

SR-300L

KATO



SR-300L

Rough Terrain Crane

Maximum rated lifting capacity: 30t × 3m
Maximum boom length: 30.5m
Engine output: 200kW / 2,600min⁻¹(ISO Net)



Address inquiries to :

<http://www.kato-works.co.jp>

NOTE : Illustrations may include optional equipment. KATO products and specifications are subject to improvements and changes without notice.



KATO

QUALITY & EXPERIENCE
SINCE 1895

KATO WORKS CO.,LTD.

9-37, Higashi-ohi 1-chome, Shinagawa-ku, Tokyo 140-0011 Japan.

Tel. : Head Office Tokyo(03)3458-1111

Overseas Marketing Department Tokyo(03)3458-1115

Fax. : Tokyo(03)3458-1163

URL <http://www.kato-works.co.jp>

Innovations For The Future

KATO WORKS CO.,LTD.

Powerful & Reliable 4 section round shaped SUPERBOOM

SR-300L

Fully Hydraulic operated solid 30.5m SUPERBOOM combined with 13m Fly-jib offers you wider working ranges and quick erection in narrow spaces

- Maximum Lifting Capacity — 30ton×3.0m
- Boom Length — 9.35m~30.5m
- Boom Derricking Angle — 0°~83°
- Jib Length — 7.9m & 13.0m
- Jib Off-set Angle — 5°, 25°, 45°
- Maximum Lifting Height — 31.2m (Boom)
44.8m (Jib)

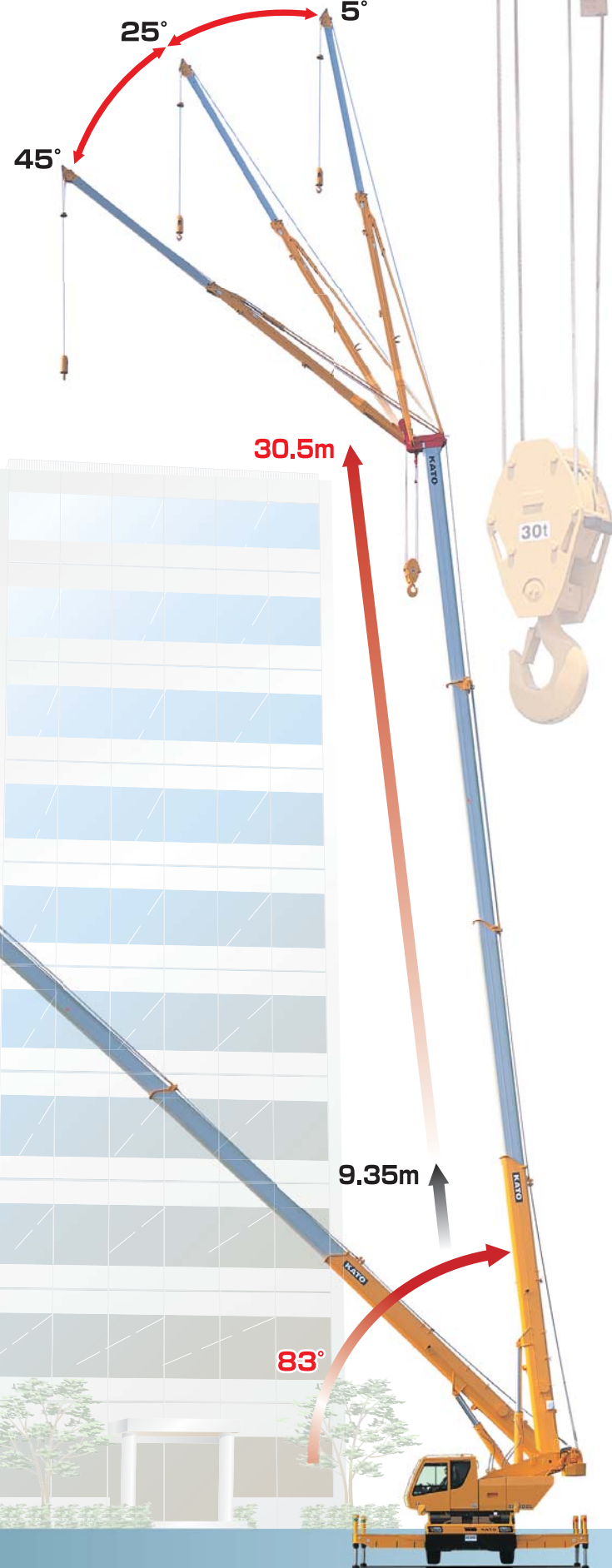

Outrigger Width

Comfortable operator's cab for the Professional Works

New ACS Moment Limiter Compuload (MS-200) with outrigger width detector and working range limiting function

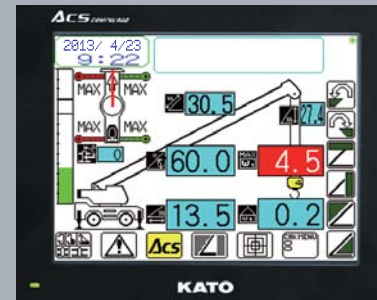

- Easy touch panel operation
- High quality color display
- Working range limiting function

- Big size new cluster meter
- Air duct (option)
- Durable switches

- Joystick control levers
- Fatigue free adjustable seat



Safe and Steady

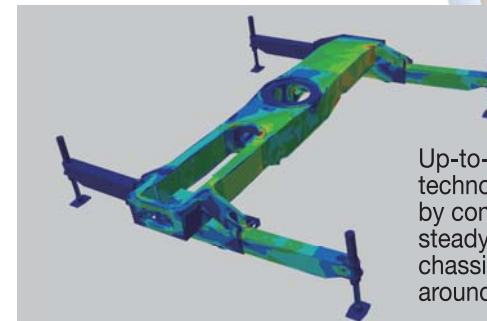

Up-to-dated design technologies assisted by computer assure steady and rigid chassis frame while all around lifting works.



Making front view wider and assuring more safety at travelling with lower position of boom foot pin and smaller front overhang.

SR-300L

ROUGH TERRAIN CRANE

【SPECIFICATION】

■ CRANE Specification

Maximum rated lifting capacity	30ton × 3m
Boom length	9.35m — 30.5m (4 section)
Fly jib length	7.9m — 13.0m (2 section, offset 5°, 25°, 45°)
Maximum rated lifting height	31.2m (Boom) 44.8m (jib)
Hoisting line speed (winch up)	Main winch 125m / min. (at 4th layer)
	Auxiliary winch 116m / min. (at 3rd layer)
Hoisting hook speed (winch up)	Main winch (Parts of line; 9) : 13.8m / min. (at 4th layer)
	Auxiliary winch (Parts of line; 1) : 116m / min. (at 3rd layer)
Boom derricking angle	0° — 83°
Boom derricking time	40s / 0° — 83°
Boom extending speed	9.35m — 30.5m / 93s
Slewing speed	2.9min ⁻¹
Tail slewing radius	3,500mm

● Equipment and structure

Boom type	Box-shaped, 4-section hydraulically telescopic type (Boom section 3 / 4 simultaneously operated)	
Jib type	2 sections (2nd section of draw-out type) (offset angles 5°, 25° and 45°)	
Boom extension/retraction equipment	Two hydraulic cylinders and wire ropes used together	
Boom derricking/lowering equipment	One hydraulic cylinder of direct acting type with pressure-compensated flow control valve	
Winch system Main & Auxiliary winches	Driven by axial plunger type hoisting motor through planetary gear reduction. Controlled independently by respective operating lever. Equipped with automatic brake.	
Slewing equipment	Ball bearing type	
Outriggers	Type	Hydraulic H-beam type (with float and vertical cylinder in single unit)
	Extension width	6,600mm (Fully extended)
		6,000mm (Intermediately extended)
		5,000mm (Intermediately extended)
		3,800mm (Intermediately extended)
2,310mm (Fully retracted)		
Wire rope for hoisting	Main winch	Diameter: 16mm × Length: 175m
	Auxiliary winch	Diameter: 16mm × Length: 95m

● Hydraulic equipment

Oil pump	4 pumps, plunger and gear type	
Hydraulic motor	Hoisting motor	Axial plunger type
	Slewing motor	Axial plunger type
Control valve	Double acting with integral check and relief valves	
Cylinder	Double acting type	
Oil reservoir capacity	500L	

● Safety devices

	ACS (Automatic Crane System with voice alarm), Slewing automatic stop system, Outrigger status detector, Boom derricking / telescoping holding valve, Overhoist prevention device, Drum lock device (on aux. winch), Winch holding valve, Automatic winch brake, Winch drum roller, Hydraulic safety valves, Outrigger lock pins, Slewing lock, Joystick control safety stop system, Hydraulic oil temperature warning device, Hydraulic oil return filter warning device
--	---

● Standard equipment

	Hydraulic oil cooler, Working light (on boom, table and cab), Winch drum turning indication device
--	--

● Operator's cab

	All steel welded construction, 1 person, Rubber mounted, Adjustable steering wheel, Adjustable seat, Seat belt, Front windscreen wiper & washer (2 speed wiper), Roof window wiper & washer, Cigarette lighter, Ashtray, Floor mat
--	--

● Optional equipment

	Winch over unwinding device, Winch drum mirror (Hoist mirror), Cab heater, Cab cooler, Fan, AM/FM Radio, Fire extinguisher, Smoke torch
--	---

■ CARRIER Specification

Maximum traveling speed	49km/h
Grade ability (tan θ)	57% (computed at G.V.W. = 26990kg)
Minimum turning radius (center of extreme outer tire)	8.2m (2 wheel steer)
	4.9m (4 wheel steer)

● Engine

Model	Mitsubishi 6M60-TL
Type	4 cycle, 6 cylinders, water cooled, direct injection turbo-charged diesel engine with intercooling
Piston displacement	7.545L
Max. power	200kW at 2,600min ⁻¹
Max. torque	785N·m at 1,400min ⁻¹
Fuel due to KATO's recommendation only	

● Equipment and structure

Drive system	4x2 / 4x4	
Torque converter	Engine mounted 3 elements 1 stage (with lock up clutch)	
Transmission	Remote mounted full automatic	
Number of speeds	4 forward & 1 reverse speed (with HI - Low selector)	
Axles	Front	Planetary, drive/steer type
	Rear	Planetary, drive/steer type
Suspension	Front & Rear	Taper - leaf spring Hydraulic locking device with shock absorber
	Service	Air-over hydraulic disk brake on 4 wheels (front and rear independent circuit)
Brake system	Parking	Spring applied, electrically air released parking brake mounted on front axle, internal expanding type
	Auxiliary	Exhaust brake
Steering	Full hydraulic power steering Completely independent front and rear steering (with automatic rear wheel steering lock system)	
Tire size	Front	385 / 95 R25 170E ROAD
	Rear	385 / 95 R25 170E ROAD
Fuel tank capacity	300 L	
Batteries	(12V-120AH) × 2	

● Safety devices

	Emergency steering device, Rear wheel steering lock system (automatic), Mis-shifting prevention system, Brake fluid leak warning device, Service brake lock, Suspension lock, Engine overspeed alarm, Radiator coolant level warning device, Air filter service warning device
--	--

● Standard equipment

	Centralized lubricating system
--	--------------------------------

● Optional equipment

	Yellow rev. light
--	-------------------

■ GENERAL Dimensions

Overall length	11,360mm	
Overall width	2,620mm	
Overall height	3,475mm	
Wheel base	3,650mm	
Treads	Front	2,170mm
	Rear	2,170mm
Passenger capacity	One person	
Gross vehicle mass	Gross weight	approx. 26,990kg
	Front weight	approx. 13,000kg
	Rear weight	approx. 13,990kg

● Stow the hooks in place before traveling.



● Before you use this machine, read the precautions in the instruction manual thoroughly to operate it correctly.

● KATO products and specifications are subject to improvements and changes without notice.

RATED LIFTING CAPACITY

Based on ISO 4305

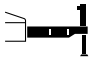
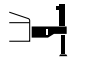
9.35m — 30.5m Boom

Working radius (m)	 (6.6m)				 (6.0m)				 (5.0m)				 (3.8m)				 (blocked on vertical cylinders)			
	Outriggers fully extended (360° full range)				Outriggers intermediately extended (over side)				Outriggers intermediately extended (over side)				Outriggers intermediately extended (over side)				Outriggers completely retracted (over side)			
	9.35m Boom	16.4m Boom	23.45m Boom	30.5m Boom	9.35m Boom	16.4m Boom	23.45m Boom	30.5m Boom	9.35m Boom	16.4m Boom	23.45m Boom	30.5m Boom	9.35m Boom	16.4m Boom	23.45m Boom	30.5m Boom	9.35m Boom	16.4m Boom	23.45m Boom	30.5m Boom
2.5	30.00*	19.00	12.50		30.00*	19.00	12.50		30.00*	19.00	12.50		30.00*	19.00	12.50		12.00	10.35	9.10	
3.0	30.00*	19.00	12.50		30.00*	19.00	12.50		30.00*	19.00	12.50		26.00	18.90	12.50		11.15	8.25	7.50	
3.5	27.20*	19.00	12.50	7.50	27.20*	19.00	12.50	7.50	27.20*	19.00	12.50	7.50	20.20	15.20	12.50	7.50	9.00	6.75	6.30	5.50
4.0	23.00	19.00	12.50	7.50	23.00	19.00	12.50	7.50	23.00	19.00	12.50	7.50	16.35	12.60	11.40	7.50	7.45	5.60	5.35	5.15
4.5	21.20	18.65	12.50	7.50	21.20	18.65	12.50	7.50	21.20	17.30	12.50	7.50	13.65	10.65	9.85	7.50	6.25	4.65	4.60	4.50
5.0	19.40	17.30	12.50	7.50	19.40	17.30	12.50	7.50	18.85	14.70	12.50	7.50	11.40	9.10	8.60	7.50	5.30	3.95	3.95	3.95
5.5	17.80	16.15	12.50	7.50	17.80	16.15	12.50	7.50	15.65	12.65	11.80	7.50	9.50	7.90	7.55	7.25	4.50	3.30	3.45	3.45
6.0	16.30	15.15	12.25	7.50	16.30	15.15	12.25	7.50	13.15	11.05	10.45	7.50	8.10	6.90	6.70	6.50	3.85	2.80	3.00	3.05
6.5	15.10	14.25	11.50	7.50	15.10	13.50	11.50	7.50	11.25	9.75	9.35	7.50	7.05	6.05	6.00	5.85	3.30	2.35	2.60	2.70
7.0		13.45	10.80	7.50		12.00	10.80	7.50		8.70	8.40	7.50		5.35	5.40	5.35		2.00	2.25	2.40
7.5		12.70	10.20	7.50		10.75	10.20	7.50		7.75	7.60	7.40		4.75	4.85	4.85		1.65	1.95	2.15
8.0		11.80	9.65	7.50		9.65	9.35	7.50		7.00	6.95	6.80		4.25	4.40	4.45		1.40	1.70	1.90
9.0		9.70	8.65	6.80		7.95	7.85	6.80		5.75	5.80	5.75		3.40	3.60	3.70		0.90	1.25	1.50
10.0		7.90	7.85	6.15		6.50	6.70	6.15		4.70	4.90	4.95		2.75	3.00	3.15		0.55	0.90	1.15
11.0		6.50	6.90	5.60		5.35	5.75	5.60		3.85	4.20	4.30		2.20	2.50	2.65			0.60	0.85
12.0		5.45	6.00	5.10		4.50	5.00	5.05		3.15	3.60	3.75		1.75	2.10	2.30				0.65
13.0		4.55	5.20	4.70		3.75	4.35	4.50		2.60	3.10	3.30		1.35	1.70	1.95				
13.5		4.20	4.85	4.50		3.45	4.05	4.20		2.40	2.90	3.05		1.20	1.55	1.80				
14.0			4.50	4.35			3.75	4.00			2.70	2.90			1.40	1.65				
15.0			3.90	4.05			3.25	3.55			2.30	2.55			1.15	1.40				
16.0			3.45	3.75			2.85	3.20			2.00	2.25			0.95	1.15				
17.0			3.00	3.35			2.50	2.85			1.70	1.95			0.75	1.00				
18.0			2.65	2.95			2.15	2.50			1.45	1.75			0.60	0.80				
19.0			2.35	2.65			1.90	2.20			1.20	1.55				0.65				
20.0			2.05	2.35			1.65	2.00			1.05	1.35				0.50				
20.5			1.95	2.25			1.55	1.85			0.95	1.25								
21.0				2.10				1.75				1.15								
22.0				1.90				1.55				1.00								
24.0				1.50				1.20				0.70								
26.0				1.20				0.95				0.50								
27.9				0.95				0.70												
Standard hook	for 30 ton				for 30 ton				for 30 ton				for 30 ton				for 30 ton			
Hook mass	250kg				250kg				250kg				250kg				250kg			
Parts of line	9°/7	6	4	4	9°/7	6	4	4	9°/7	6	4	4	9°/7	6	4	4	7	6	4	4
Critical boom angle	—	—	—	—	—	—	—	—	—	—	—	20°	—	—	28°	41°	—	40°	55°	62°

(Unit : Metric ton)

30.5m Boom + 7.9m Jib

Outriggers fully extended (360° full range)							Outriggers intermediately extended (over side)							Outriggers intermediately extended (over side)						
Boom angle (°)	Offset 5°		Offset 25°		Offset 45°		Boom angle (°)	Offset 5°		Offset 25°		Offset 45°		Boom angle (°)	Offset 5°		Offset 25°		Offset 45°	
	Working radius (m)	Load (ton)	Working radius (m)	Load (ton)	Working radius (m)	Load (ton)		Working radius (m)	Load (ton)	Working radius (m)	Load (ton)	Working radius (m)	Load (ton)		Working radius (m)	Load (ton)	Working radius (m)	Load (ton)	Working radius (m)	Load (ton)
83.0	4.5	3.50	7.2	2.40	9.1	1.70	83.0	4.5	3.50	7.2	2.40	9.1	1.70	83.0	4.5	3.50	7.2	2.40	9.1	1.70
75.0	10.5	3.50	12.6	2.40	14.1	1.70	75.0	10.5	3.50	12.6	2.40	14.1	1.70	75.0	10.5	3.50	12.6	2.40	14.1	1.70
73.0	11.9	3.35	13.9	2.40	15.3	1.69	73.0	11.9	3.35	13.9	2.40	15.3	1.69	73.0	11.9	3.35	13.9	2.40	15.3	1.69
71.0	13.2	3.11	15.2	2.32	16.5	1.66	71.0	13.2	3.11	15.3	2.32	16.5	1.66	72.0	12.5	3.23	14.6	2.37	15.9	1.68
69.0	14.5	2.89	16.3	2.19	17.6	1.63	69.0	14.5	2.89	16.3	2.19	17.6	1.63	71.0	13.1	2.98	15.3	2.32	16.5	1.66
65.0	16.9	2.45	18.7	1.94	19.8	1.57	65.0	16.9	2.45	18.7	1.94	19.8	1.57	69.0	14.3	2.55	16.3	2.19	17.6	1.63
61.0	19.2	2.12	20.9	1.73	21.8	1.53	64.0	17.5	2.35	19.3	1.88	20.3	1.56	66.0	16.3	1.92	18.0	1.76	19.3	1.58
58.0	20.8	1.92	22.5	1.60	23.3	1.47	63.0	18.1	2.27	19.8	1.83	20.8	1.55	61.0	18.7	1.35	20.6	1.20	21.7	1.15
55.0	22.4	1.68	24.0	1.49	24.6	1.39	61.0	19.1	2.01	20.9	1.73	21.8	1.53	55.0	21.8	0.81	23.4	0.74	24.3	0.71
54.0	22.8	1.60	24.4	1.46	25.0	1.37	59.0	20.2	1.78	21.9	1.62	22.8	1.50	53.0	22.8	0.67	24.4	0.60	25.1	0.59
50.0	24.8	1.26	26.2	1.16	26.6	1.16	55.0	22.2	1.37	23.7	1.29	24.5	1.25	51.0	23.8	0.53	25.3	0.50	26.0	0.47
46.0	26.6	0.99	27.8	0.93	28.0	0.93	46.0	26.4	0.75	27.7	0.71	27.9	0.71	Standard hook for 4.0 ton						
40.0	28.9	0.69	29.8	0.68			45.0	26.8	0.70	28.0	0.67			Hook mass 80kg						
34.0	31.0	0.46	31.7	0.45			40.0	28.8	0.48	29.8	0.46			Parts of line 1						
Standard hook for 4.0 ton							Standard hook for 4.0 ton							Critical boom angle 49° 49° 49°						
Hook mass 80kg							Hook mass 80kg													
Parts of line 1							Parts of line 1													
Critical boom angle 32° 32° 44°							Critical boom angle 38° 38° 44°													

30.5m Boom + 7.9m Jib

Outriggers intermediately extended (over side)						
Boom angle (°)	Offset 5°		Offset 25°		Offset 45°	
	Working radius (m)	Load (ton)	Working radius (m)	Load (ton)	Working radius (m)	Load (ton)
83.0	4.5	3.50	7.2	2.40	9.1	1.70
78.0	8.3	3.50	10.6	2.40	12.2	1.70
76.0	9.6	3.13	11.9	2.40	13.5	1.70
73.0	11.4	2.31	13.8	1.87	15.3	1.69
71.0	12.6	1.87	14.9	1.55	16.4	1.41
67.0	14.9	1.22	17.1	1.03	18.3	0.97
61.0	18.3	0.56	20.2	0.48	21.3	0.45
Standard hook for 4.0 ton						
Hook mass 80kg						
Parts of line 1						
Critical boom angle 59° 59° 59°						

611-75102000

30.5m Boom + 13.0m Jib

Outriggers fully extended (360° full range)							Outriggers intermediately extended (over side)						
Boom angle (°)	Offset 5°		Offset 25°		Offset 45°		Boom angle (°)	Offset 5°		Offset 25°		Offset 45°	
	Working radius (m)	Load (ton)	Working radius (m)	Load (ton)	Working radius (m)	Load (ton)		Working radius (m)	Load (ton)	Working radius (m)	Load (ton)	Working radius (m)	Load (ton)
83.0	5.6	2.20	10.0	1.25	13.2	0.85	83.0	5.6	2.20	10.0	1.25	13.2	0.85
77.0	10.8	2.20	14.5	1.25	17.2	0.85	77.0	10.8	2.20	14.5	1.25	17.2	0.85
73.0	14.2	2.18	17.4	1.17	19.8	0.85	73.0	14.2	2.18	17.4	1.17	19.8	0.85
71.0	15.6	2.02	18.8	1.12	21.1	0.84	71.0	15.6	2.02	18.8	1.12	21.1	0.84
65.0	19.6	1.61	22.7	1.01	24.5	0.80	65.0	19.6	1.61	22.7	1.01	24.5	0.80
61.0	22.3	1.42	25.1	0.94	26.7	0.78	61.0	22.3	1.42	25.1	0.94	26.7	0.78
60.0	23.0	1.38	25.7	0.93	27.2	0.78	60.0	23.0	1.38	25.7	0.93	27.2	0.78
53.0	27.2	1.19	29.5	0.87	30.4	0.77	58.0	24.2	1.31	26.8	0.91	28.1	0.78
49.0	29.3	0.94	31.4	0.84	32.0	0.77	54.0	26.5	1.01	28.9	0.88	30.0	0.77
47.0	30.3	0.83	32.3	0.76	32.8	0.77	52.0	27.5	0.89	29.9	0.82	30.9	0.77
46.0	30.7	0.78	32.7	0.72	33.1	0.72	50.0	28.5	0.78	30.8	0.72	31.7	0.70
42.0	32.5	0.61	34.2	0.57			46.0	30.6	0.58	32.5	0.55	33.0	0.55
39.0	33.8	0.49	35.3	0.47			44.0	31.4	0.51	33.3	0.47		
Standard hook for 4.0 ton							Standard hook for 4.0 ton						
Hook mass 80kg							Hook mass 80kg						
Parts of line 1							Parts of line 1						
Critical boom angle 37° 37° 44°							Critical boom angle 42° 42° 44°						



30.5m Boom + 13.0m Jib

Outriggers intermediately extended (over side)							Outriggers intermediately extended (over side)						
Boom angle (°)	Offset 5°		Offset 25°		Offset 45°		Boom angle (°)	Offset 5°		Offset 25°		Offset 45°	
	Working radius (m)	Load (ton)	Working radius (m)	Load (ton)	Working radius (m)	Load (ton)		Working radius (m)	Load (ton)	Working radius (m)	Load (ton)	Working radius (m)	Load (ton)
83.0	5.6	2.20	10.0	1.25	13.2	0.85	83.0	5.6	2.20	10.0	1.25	13.2	0.85
77.0	10.8	2.20	14.5	1.25	17.2	0.85	77.0	10.8	2.20	14.5	1.25	17.2	0.85
73.0	14.2	2.18	17.4	1.17	19.8	0.85	76.0	11.6	2.20	15.2	1.24	17.8	0.85
71.0	15.6	2.02	18.8	1.12	21.1	0.84	71.0	15.0	1.47	18.8	1.12	21.1	0.84
68.0	17.6	1.79	20.7	1.07	22.8	0.82	69.0	16.4	1.17	20.0	0.93	22.2	0.82
62.0	21.4	1.15	24.5	0.96	26.1	0.79	67.0	17.7	0.93	21.1	0.75	23.3	0.68
60.0	22.5	0.97	25.5	0.84	27.2	0.78	64.0	19.6	0.64	22.9	0.51	24.8	0.47
58.0	23.7	0.82	26.6	0.71	28.1	0.78	Standard hook for 4.0 ton						
54.0	26.0	0.55	28.6	0.49	29.8	0.48	Hook mass 80kg						
Standard hook for 4.0 ton							Parts of line 1						
Hook mass 80kg							Critical boom angle 62° 62° 62°						
Parts of line 1													
Critical boom angle 52° 52° 52°													

611-75103000

■ When the outriggers are not used

(Unit : Metric ton)

														Working radius (m)
Working radius (m)	Stationary on rubber						Pick & carry (less than 2 km/h)							
	9.35m Boom		16.4m Boom		23.45m Boom		9.35m Boom		16.4m Boom		23.45m Boom			
	Over front	360° full range	Over front	360° full range	Over front	360° full range	Over front	360° full range	Over front	360° full range	Over front	360° full range		
3.0	13.50	8.10	9.00	6.80			10.00	6.10	6.60	5.10			3.0	
3.5	12.00	6.80	9.00	5.60	6.50	4.50	8.95	5.10	6.60	4.90	5.50	3.20	3.5	
4.0	10.75	5.80	9.00	4.65	6.50	4.45	8.00	4.30	6.60	4.10	5.50	3.20	4.0	
4.5	9.65	5.00	9.00	3.85	6.50	3.80	7.10	3.65	6.60	3.45	5.50	3.20	4.5	
5.0	8.70	4.30	8.20	3.20	6.50	3.25	6.40	3.15	6.00	2.90	5.50	2.95	5.0	
5.5	7.80	3.60	7.40	2.70	6.05	2.80	5.75	2.65	5.40	2.40	5.15	2.55	5.5	
6.0	7.00	3.00	6.60	2.25	5.65	2.45	5.20	2.25	5.00	1.95	4.80	2.20	6.0	
6.5	6.25	2.50	5.90	1.85	5.25	2.10	4.70	1.90	4.45	1.60	4.45	1.90	6.5	
7.0			5.20	1.55	4.85	1.80			3.90	1.30	4.15	1.60	7.0	
8.0			4.00	1.00	4.10	1.30			3.00	0.80	3.45	1.15	8.0	
9.0			3.15	0.60	3.50	0.95			2.40		2.80	0.80	9.0	
10.0			2.50		3.00	0.60			1.80		2.30	0.50	10.0	
11.0			2.00		2.50				1.30		1.90		11.0	
12.0			1.60		2.10				1.00		1.55		12.0	
13.0			1.25		1.75				0.75		1.25		13.0	
14.0					1.45						1.00		14.0	
15.0					1.20						0.75		15.0	
16.0					0.95						0.55		16.0	
17.0					0.75								17.0	
18.0					0.55								18.0	
Standard hook	for 30 ton						for 30 ton						Standard hook	
Hook mass	250kg						250kg						Hook mass	
Parts of line	4						4						Parts of line	
Critical boom angle	—	—	—	45°	29°	59°	—	—	—	51°	38°	58°	Critical boom angle	

■ Notes for the rated lifting capacity chart

■ When the outriggers are used

1. The rated lifting capacity charts are based on the jib stowed on the boom side.
2. The rated lifting capacity chart indicates the maximum load which can be lifted by this crane provided it is level and standing on firm level ground. The values in the chart include the mass of the main hook and slings for boom operation, and auxiliary hook and slings for jib operation. [30 ton hook (mass: 250kg), 4 ton hook (mass: 80kg)]
Within the chart the figures in the area bordered with a thick line are based on structural limitations while other figures are determined by stability limitations.
3. The working radii are the actual values allowing for boom and jib deflection. Therefore you must always operate the crane on the basis of the working radius.
4. The jib working radius is based on the jib mounted on the end of the 30.5m boom. When operating at other boom lengths, use the boom angle alone as the criterion.
5. Do not operate the jib when the outriggers are completely retracted.
6. The lifting capacities for the over sides vary with the outrigger extension width. Therefore for each outrigger extension condition you should work according the rated lifting capacity chart.
Use the rated lifting capacity chart of outriggers full extended for both front and rear areas lifting capacities.

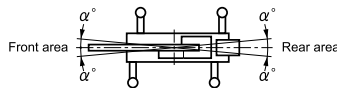

Outrigger extension status	Intermediate extension (6.0m)	Intermediate extension (5.0m)	Intermediate extension (3.8m)	Full retraction
Area α°	35	30	20	3

7. The rated lifting capacity of the rooster sheave is the rated lifting capacity of the boom minus the mass of all attached hook, slings etc. to the boom, with an upper limit of 4,000kg.
[The hook for use with the rooster sheave is the 4 ton hook (mass: 80kg) with one part of line.]
8. If the boom length, boom angle and/or working radius exceeds the rated value, use the rated lifting capacity for the rated value or for the next one, whichever gives the smaller rated lifting capacity.
9. If you are working with the boom while the jib is rigged, subtract 2.2 ton plus the mass of all attached hook, slings etc. to the boom from the each rated lifting capacity of the boom, with an upper limit of 14 ton.
Do not use the rooster sheave in this situation. And do not operate the boom while the jib is rigged, when the outriggers are retracted.
10. In whatever working conditions the corresponding boom critical angle is shown in the chart. The crane can tip over if the boom is lowered below the critical angle even if unloaded.
Therefore, never lower the boom below these angles.
11. The standard parts of line for each boom length are as indicated in the chart. If you work with a non-standard number of parts of line, do not exceed 37.2kN (3.8tf) per wire rope respectively.
12. Crane operation is permissible up to a wind speed of 10m/s. Even in relatively light wind conditions, extra care should be taken when handling loads presenting large wind catching areas.
13. Kato bears no liability whatsoever for damage, crane tipping or other accident caused by crane operations which differ from the directions contained in the instruction manual and the warning labels.

■ When the outriggers are not used

1. The rated lifting capacity charts are based on the jib stowed on the boom side.
2. The rated lifting capacity chart indicates the maximum load the crane can lift when its body is level on firm level ground with all tires inflated to the rated pressure and the suspension cylinder completely retracted. The values in the chart include the mass of the main hook and slings.
Within the chart the figures in the area bordered with a thick line are based on structural limitations while other figures are determined by stability limitations.
[Rated tire pressure: 900kPa (9.0kgf/cm²)]
3. The working radii are the actual values allowing for boom deflection. Therefore you must always operate the crane on the basis of the working radius.
4. The rated lifting capacity differs between the front area capacity and the full range capacity. When slewing from the front to the side, take care that the crane could not be over loaded.

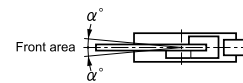

Crane operation	Stationary crane-on-rubber operation	Pick and carry operation
Area α°	1	1

5. The rated lifting capacity of the rooster sheave is the rated lifting capacity of the boom minus the mass of all attached hook, slings etc. to the boom, with an upper limit of 4,000kg.
[The hook for use with the rooster shave is the 4 ton hook (mass: 80kg) with one part of line.]
6. Do not work with the jib or with a boom length of more than 23.45m.
7. For stationary crane-on-rubber operation, the parking brake and service brake lock device must be engaged.
8. For pick and carry operation, the super-slow speed switch must be switched to "ON" and the shift lever set to speed 1.
9. For pick and carry operation, lower the load to just above the ground and keep your speed strictly below 2km/h to avoid swinging the load.
Take particular care to avoid sharp turns, sudden starts and stops.
10. Never operate the crane during pick and carry operation. The slewing brake must be applied.
11. If the boom length or working radius exceeds the rated value, use the rated lifting capacity for the rated value or for the next one, whichever gives the smaller rated lifting capacity.
12. In whatever working conditions the corresponding boom critical angle is shown in the chart. The crane can tip over if the boom is lowered below the critical angle even if unloaded.
Therefore, never lower the boom below these angles.
13. The standard parts of line for each boom length are as indicated in the chart. If you work with a non-standard number of parts of line, do not exceed 37.2kN (3.8tf) per wire rope respectively.
14. Crane operation is permissible up to a wind speed of 10m/s. Even in relatively light wind conditions, extra care should be taken when handling loads presenting large wind catching areas.
15. Kato bears no liability whatsoever for damage, crane tipping or other accident caused by crane operations which differ from the directions contained in the instruction manual and the warning labels.

WORKING RANGE

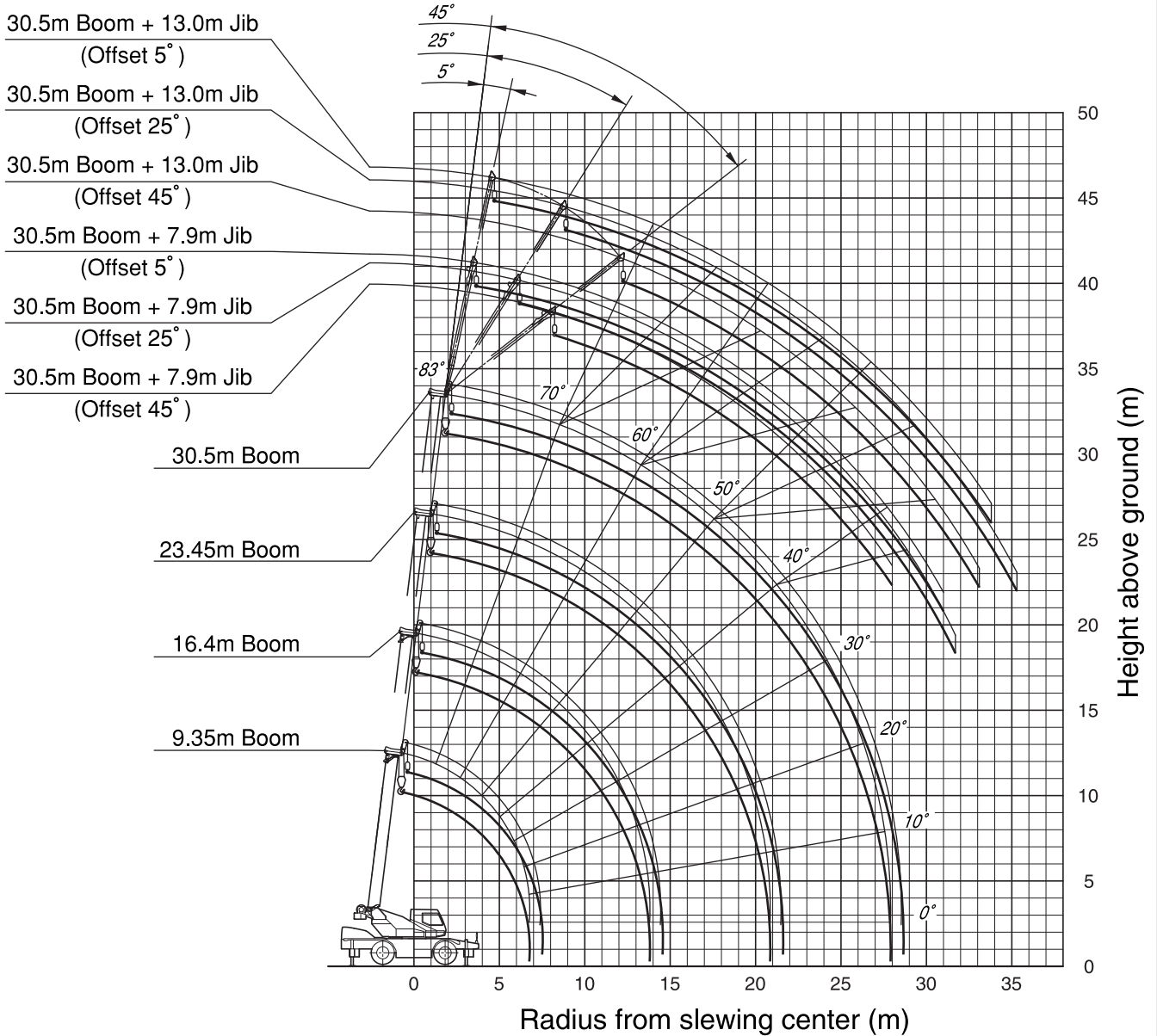

Note:

1. This diagram does not include deflection of Boom and Fly jib.
2. The outriggers are fully extended.

Minimum path width

● Left turn in two-wheel steering mode

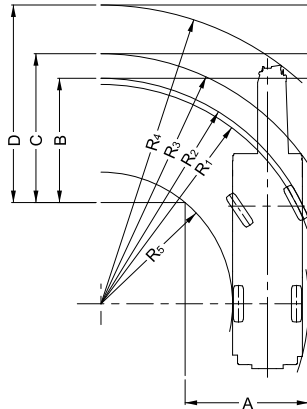

- $R_1=8.20\text{m}$
(Minimum turning radius)
- $R_2=8.40\text{m}$
(Turning radius of extremely outer tyre)
- $R_3=9.35\text{m}$
(Chassis turning radius)
- $R_4=11.17\text{m}$
(Boom end turning radius)
- $R_5=4.92\text{m}$
(Turning radius extremely chassis inner)
- $A=4.63\text{m}$ (Width of entrance)
- $B=4.63\text{m}$ (Width of wheel exit)
- $C=5.57\text{m}$ (Width of chassis exit)
- $D=7.39\text{m}$ (Width of exit at end of boom)

● Left turn in 4-wheel steering mode

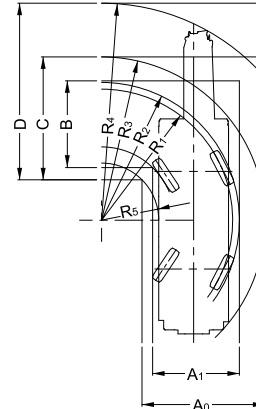

- $R_1=4.90\text{m}$
(Minimum turning radius)
- $R_2=5.10\text{m}$
(Turning radius of extremely outer tyre)
- $R_3=6.10\text{m}$
(Chassis turning radius)
- $R_4=8.12\text{m}$
(Boom end turning radius)
- $R_5=2.10\text{m}$
(Turning radius extremely chassis inner)
- $A_0=4.60\text{m}$ (Width of entrance)
- $A_1=3.25\text{m}$ (Width of wheel entrance)
- $B=3.25\text{m}$ (Width of wheel exit)
- $C=4.60\text{m}$ (Width of chassis exit)
- $D=6.61\text{m}$ (Width of exit at end of boom)

Note: The above values are based on calculations.

Overall view

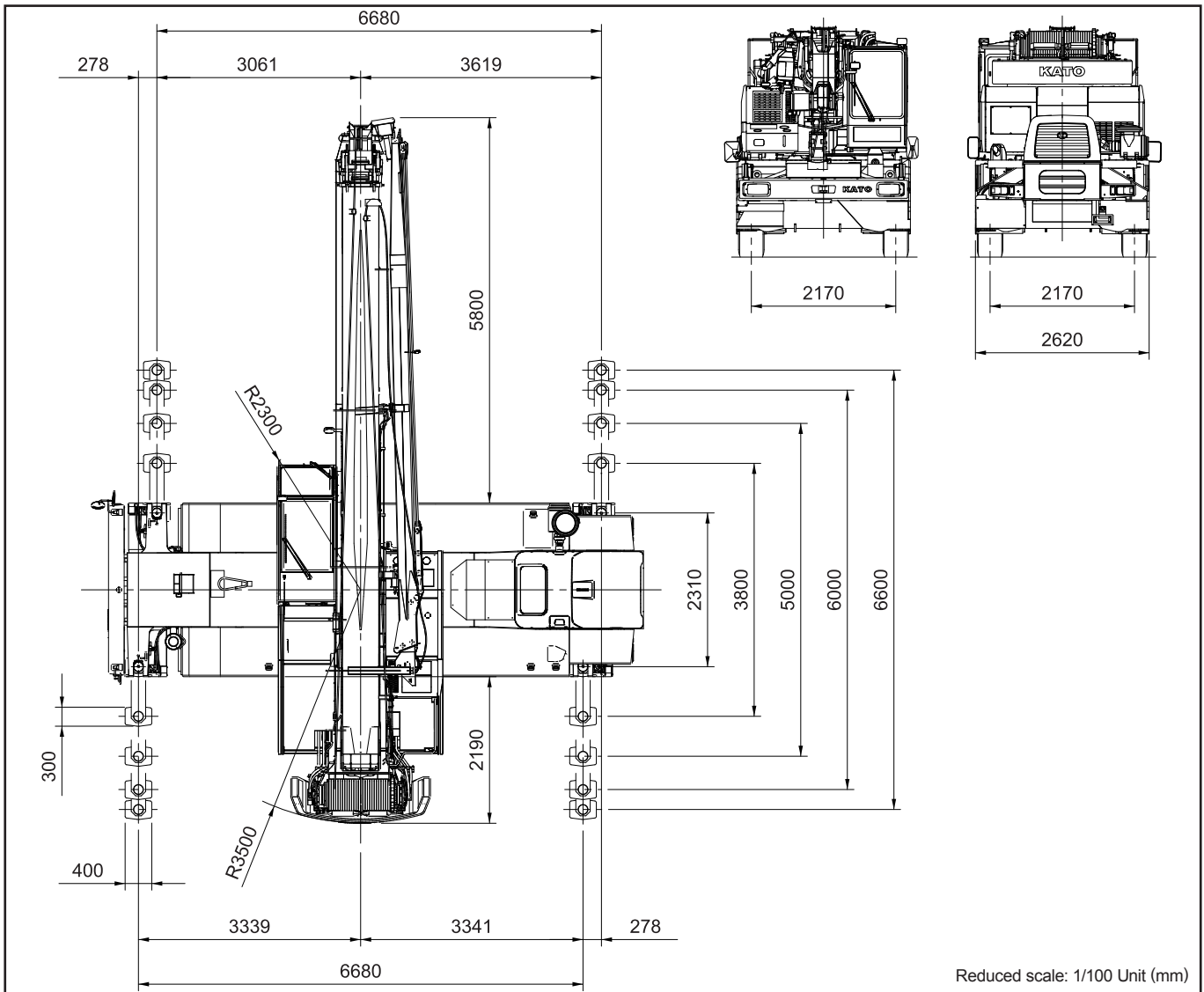

Reduced scale: 1/100 Unit (mm)

Overall view

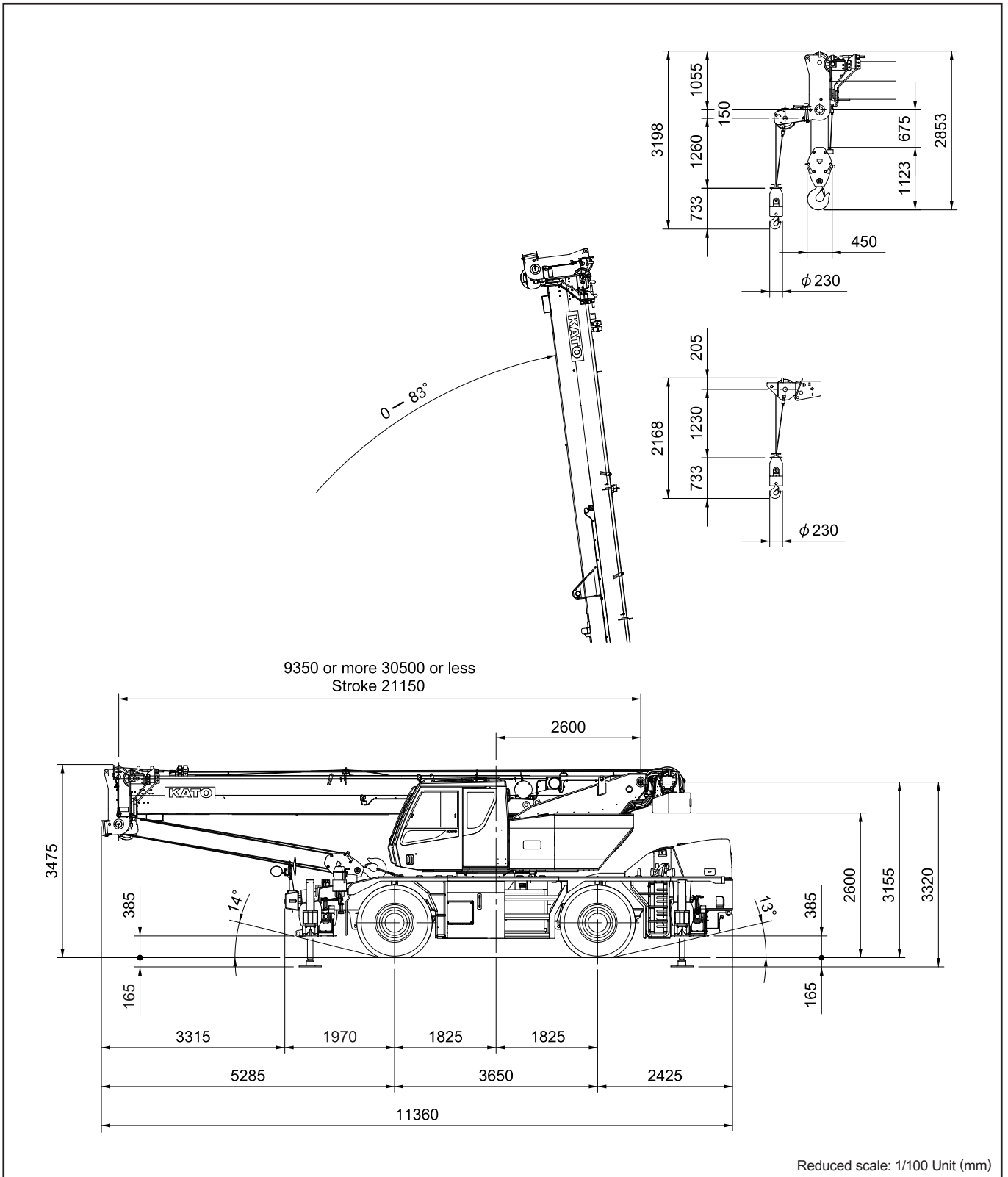

* KATO products and specifications are subject to improvements and changes without notice.

Address inquiries to:

KATO

KATO WORKS CO.,LTD.

9-37, Higashi-ohi 1-chome, Shinagawa-ku, Tokyo, 140-0011, Japan

Tel. : Head Office Tokyo (03) 3458-1111
Overseas Marketing Department. Tokyo (03) 3458-1115

Fax. : Tokyo (03) 3458-1152

URL <http://www.kato-works.co.jp>

C03391

4.2013-1000 (TI) 1



We acquired the "ISO 9001" certification which is an international standard for quality assurance.